

180 Lm/W



SLIM PLUS

LED HIGH MAST FLOOD LIGHT

LSHM-800W-LV(XXK)PLUS

LSHM-960W-LV(XXK)PLUS

LSHM-1200W-LV(XXK)PLUS

800W 960W 1200W

For area lighting for applications:

Airports, Golf course | Sport Fields | Stadiums|

Shopping Centers | Prisons | Expressways |

Industrial Facilities and Railway Terminals etc.





SILM PLUS SERIES

SILM Plus series LED HIGH MAST LIGHT is built with robust Folding aluminum fin module housing and heavy duty anticorrosive surface treatment for sparking the beauty and improving lighting conditions of applied area. Originated by the demand for large field lighting applications, SILM Plus series flood lights can be extended to 1500W and fixture efficacy reaches to 170LPW, better brilliance, less energy consumption.

IP66 WATERPROOF & IK10

1. High luminaire efficiency up to 180lm/w
2. Marine grade aluminum housing
3. IP66 and IK10 protection rate
4. 5 years warranty



FOLDING ALUMINUM FIN DESIGN

Folding aluminum fin design which are very light weight. Increase the heat dissipation surface area by air cooling to dissipate heat and expand the contact area with air! It speeds up the spread of heat! Thermal effect is good! Compared with traditional die-cast aluminum and profile aluminum, which is heavier and there are certain safety risks. On the contrary, the aluminum fin heat sink are more secure.



SLIM PLUS SERIES LED HIGH MAST LIGHT



▼ Features

1. High luminaire efficiency up to 180lm/w
2. Marine grade aluminum housing
3. IP66 and IK10 protection rate
4. 5 years warranty
5. Non-flickering drivers
6. Folding aluminum fin design which are very light weight
7. TUV CE CB SAA RoHS LM79 LM80 TM21 IK10 Salt Spray test approved

5
Years
Warranty

50000 Hour
Long Service Life

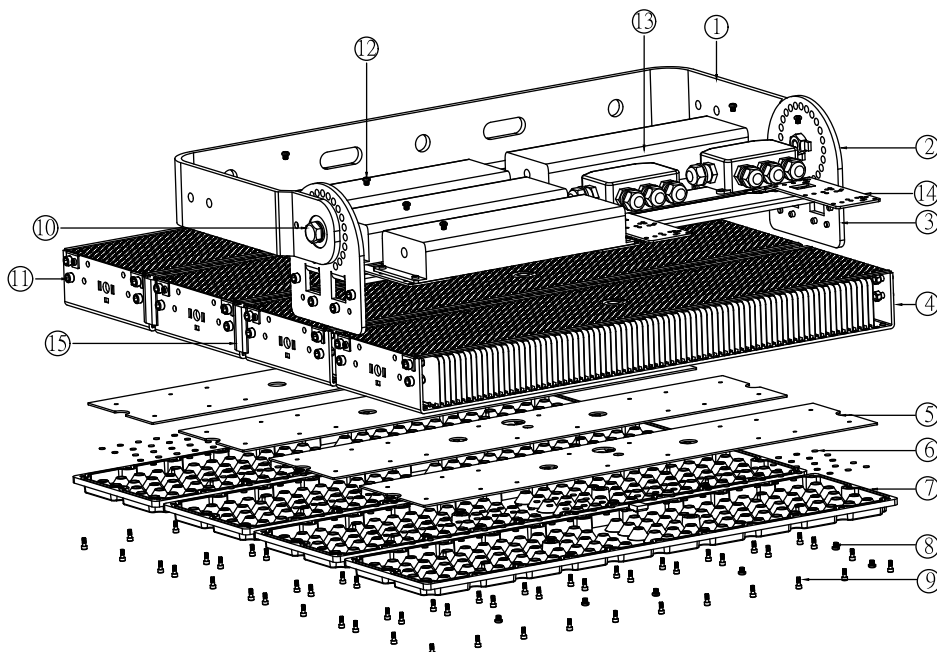

SLIM PLUS

LED HIGH MAST LIGHTS 800W 960W 1200W

- Light Source:Luminleds 5050
- Input Volt: 100-277VAC
- IP Rating IK Rating : IP66 & IK10
- Beam Angle:10° 20° 40° 60° 90° Type4 135*60° (P50)
- Color Temp: 3000K 4000K 5000K 5700K 6000K
- 5 years warranty



100-277VAC



374-480VAC



50,000H



Modules



-30~45°C



IK10



IP66



FLAME RETARDED



SALT SPRAY TEST

Technical Specifications

| Part Number | LSHM-800W-LV(XXK)PLUS | LSHM-960W-LV(XXK)PLUS | LSHM-1200W-LV(XXK)PLUS |
|-------------|-------------------------------|-------------------------------|--------------------------------|
| Watt | 800W | 960W | 1200W |
| Efficiency | 180lm/w±3% | 170lm/w±3% | 160lm/w±3% |
| Chip Brand | Luminleds 5050 | Luminleds 5050 | Luminleds 5050 |
| Lumen | 144,000Lm | 163,200Lm | 192,000Lm |
| Driver | Meanwell Driver 4*ELG-240-48A | Meanwell Driver 4*ELG-240-48A | Meanwell Driver 4*ELGC-300-H-A |
| Dimensions | 565x582x155mm | 565x582x155mm | 565x582x155mm |
| Weight | 16KG | 16KG | 18KG |

Dimensional

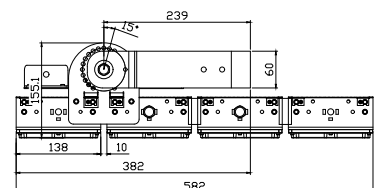
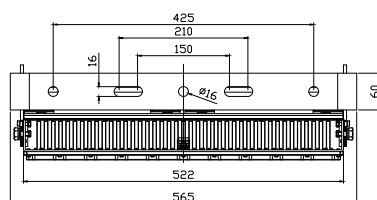
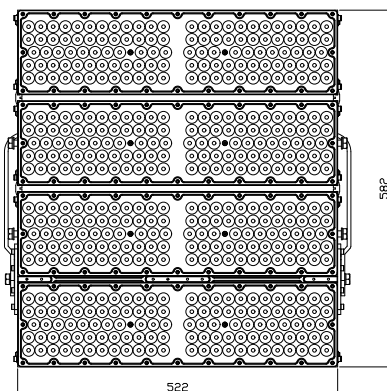

Beam Angle

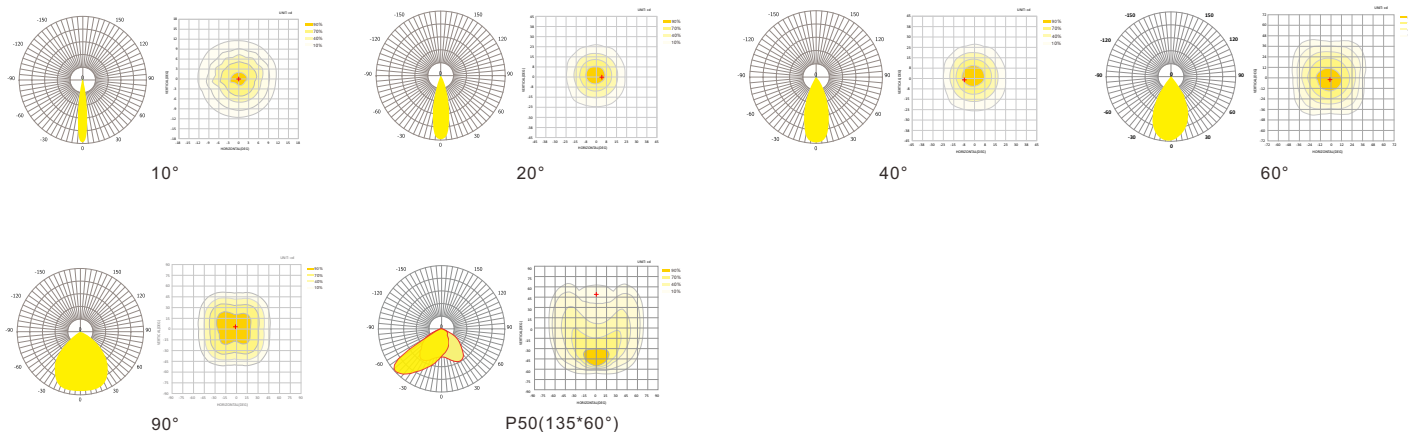

Application

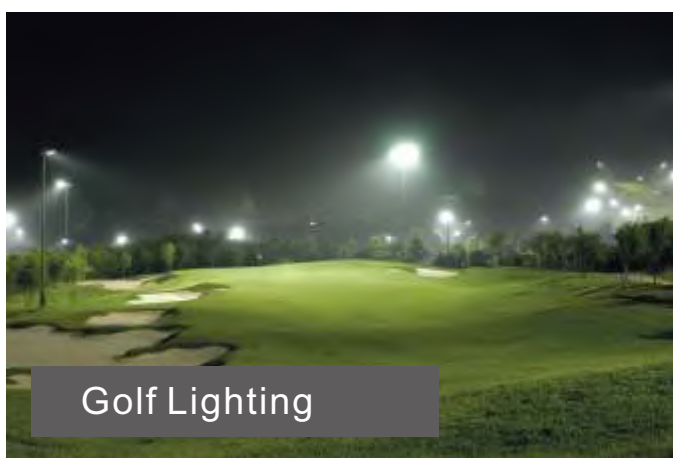
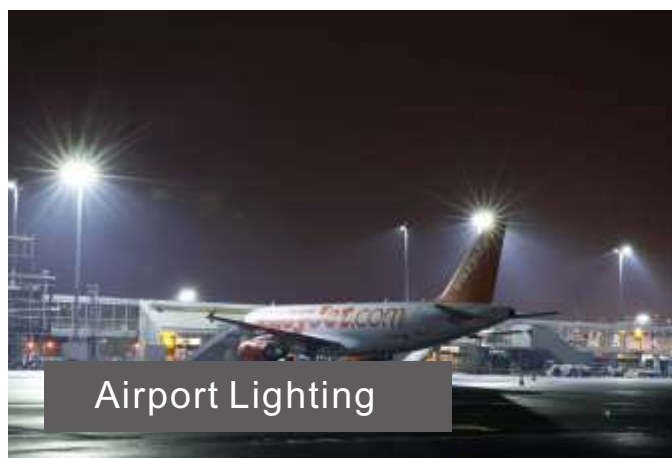

For area lighting for interior and exterior applications:
airport, golf course, factories, plants, warehouse, exhibition halls, gym, seaport, highway, high mast lighting and etc.

Package details

| Wattage | Size of Box | Weight | Box Quantity |
|---------------|-------------|--------|--------------|
| 800/960/1200W | 66x64x22cm | 22Kg | 1PC |